

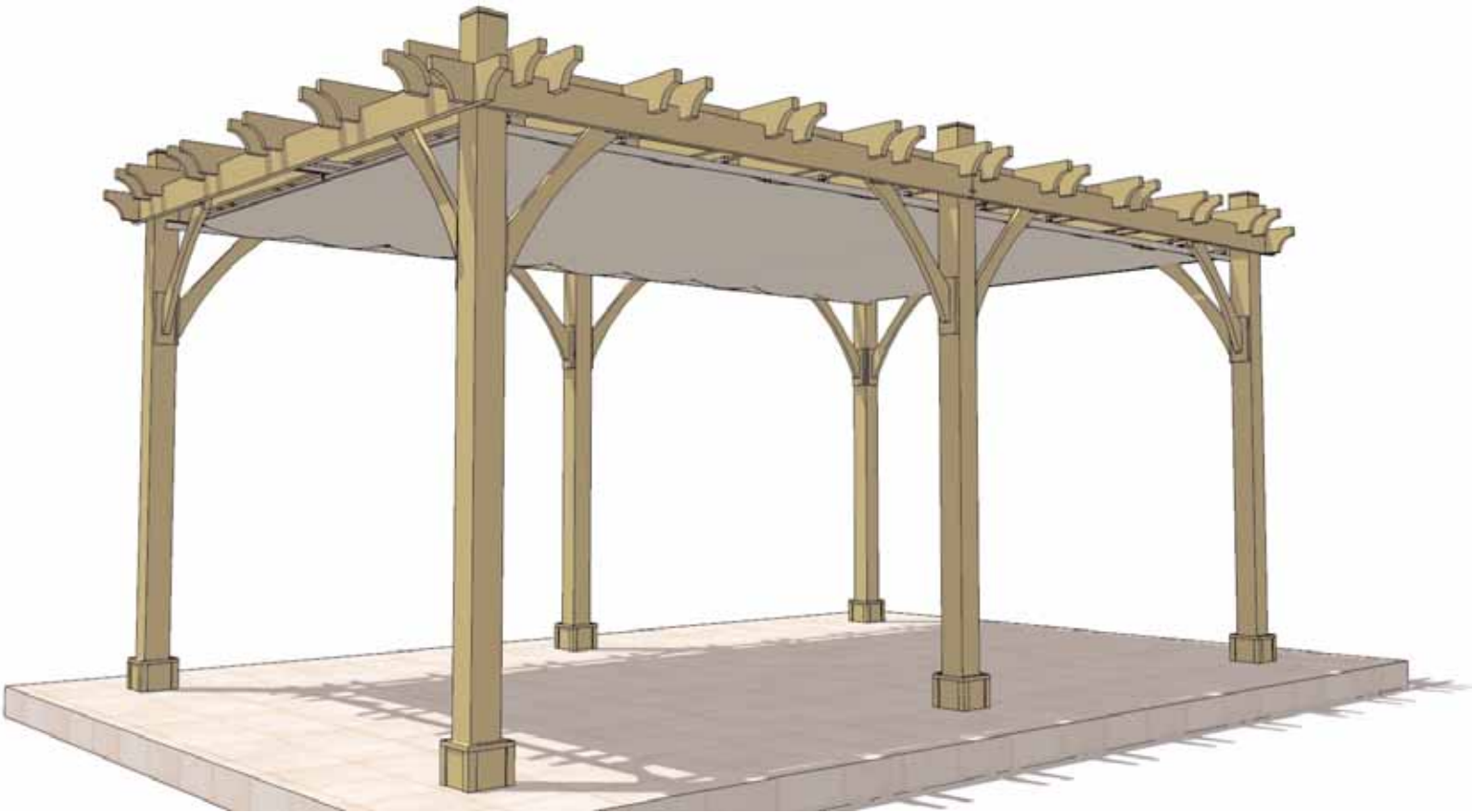

Assembly Manual: Retractable Canopy for 12X20 Shade Voila Pergola



Care and Maintenance -

Our canopies are designed to be maintenance free. Reasonable care to remove accumulated dirt and debris is all that is required to get 10 or more years of enjoyment out of your Shade Voila Pergola Canopy.

Customers agree to hold Shade Voila and any Authorized Dealers free of any liability for improper installation, maintenance and repair of any Shade Voila products.

In the event of a missing or broken piece, simply call the Shade Voila Customer Support Line @ 1-866-519-6150 within 30 days of the delivery of your purchase. It is our commitment to you to courier replacement parts, free of charge, within 10 business days of this notification. Replacement parts will not be provided free of charge after the 30 day grace period.

12x20 Utopia Pergola Retractable Canopy Parts List

Parts List

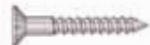

16 - 1 1/4" Flat Head Screws - Wing Supports



8 - 1 1/2" Pan Head Screws (Drive Beam Flange)



2 - 1 1/2" Self Taping Screws (Drive Beam/Joist)



Allen Wrench

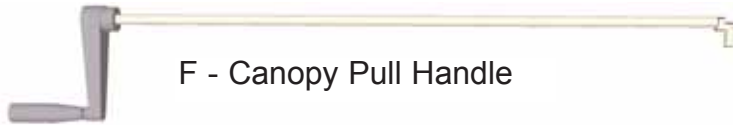

F - Canopy Pull Handle

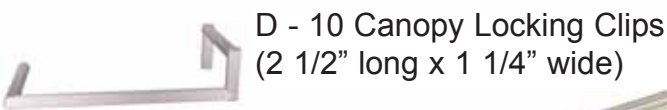

D - 10 Canopy Locking Clips
(2 1/2" long x 1 1/4" wide)



A & B - 2 Drive Beams- 120" long each

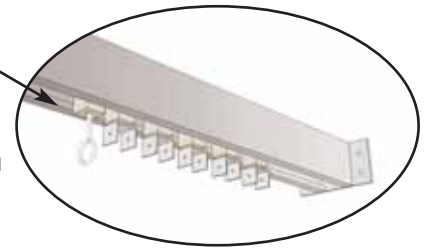

C - Canopy Fabric and Aluminum Wings - 132" long



E - 4 Wing Supports - 120" long

Tools Required (Not Provided)



Screw Gun/Drill



Level



Tape Measure



Wood Clamp



Ladders

Safety Equipment Required (Not Provided)



Safety Glasses



Work Gloves

Installation of the Shade Voila Retractable Canopy couldn't be easier.

1. Attach Drive Beams together.
2. Attach Drive Beam to Outside Girders (1 1/2" PH Screws) and to underside of Joists (1 1/2" ST Screws).
3. Connect Canopy Fabric with Aluminum Wing Supports to Drive Beam with supplied Locking Clips.
4. Attach Wing Supports (1 1/4" FH Screws).
5. Using Canopy Pull Handle, retract the Canopy and tighten to desired position!

Installation will require 2 people.

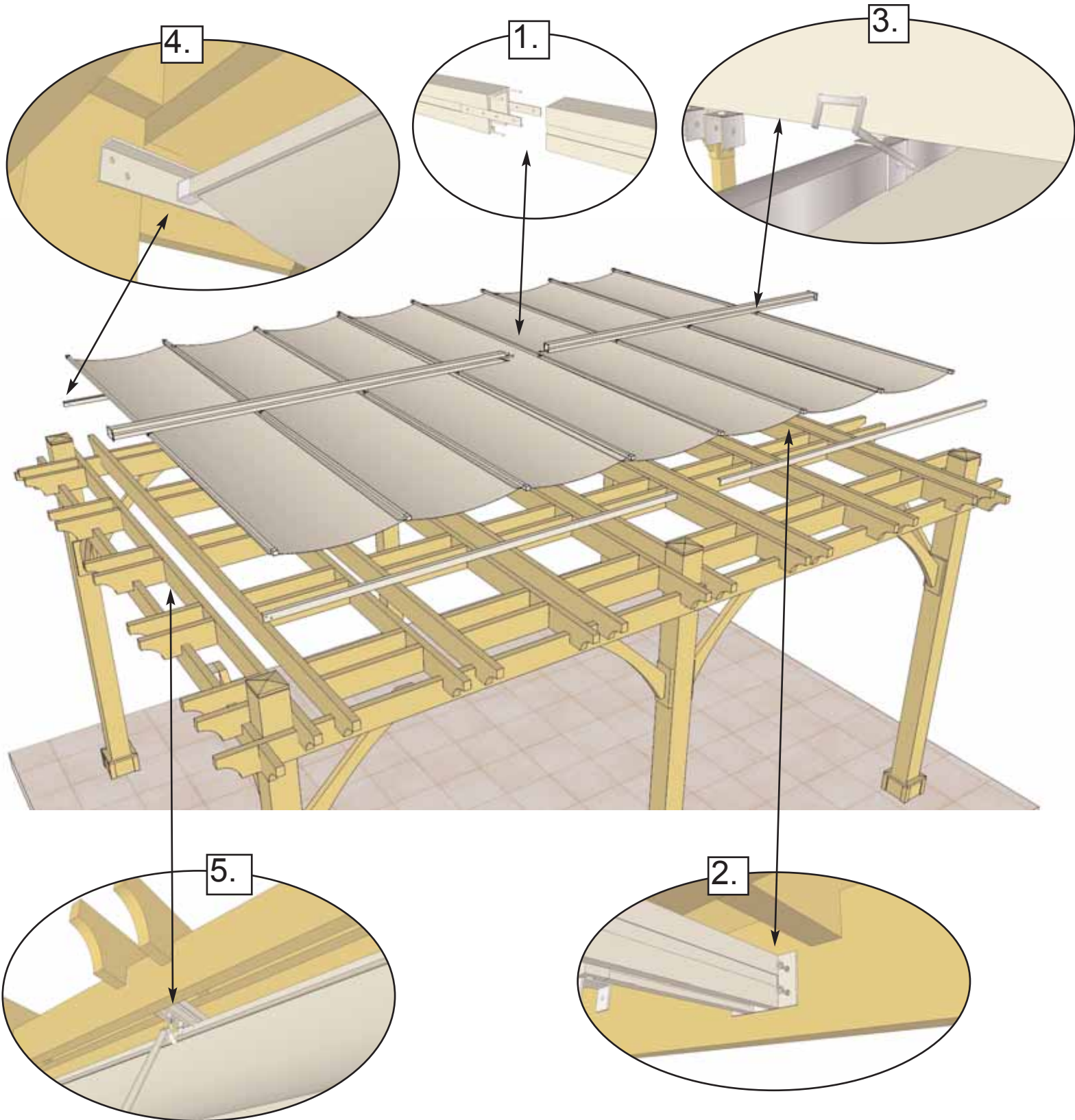

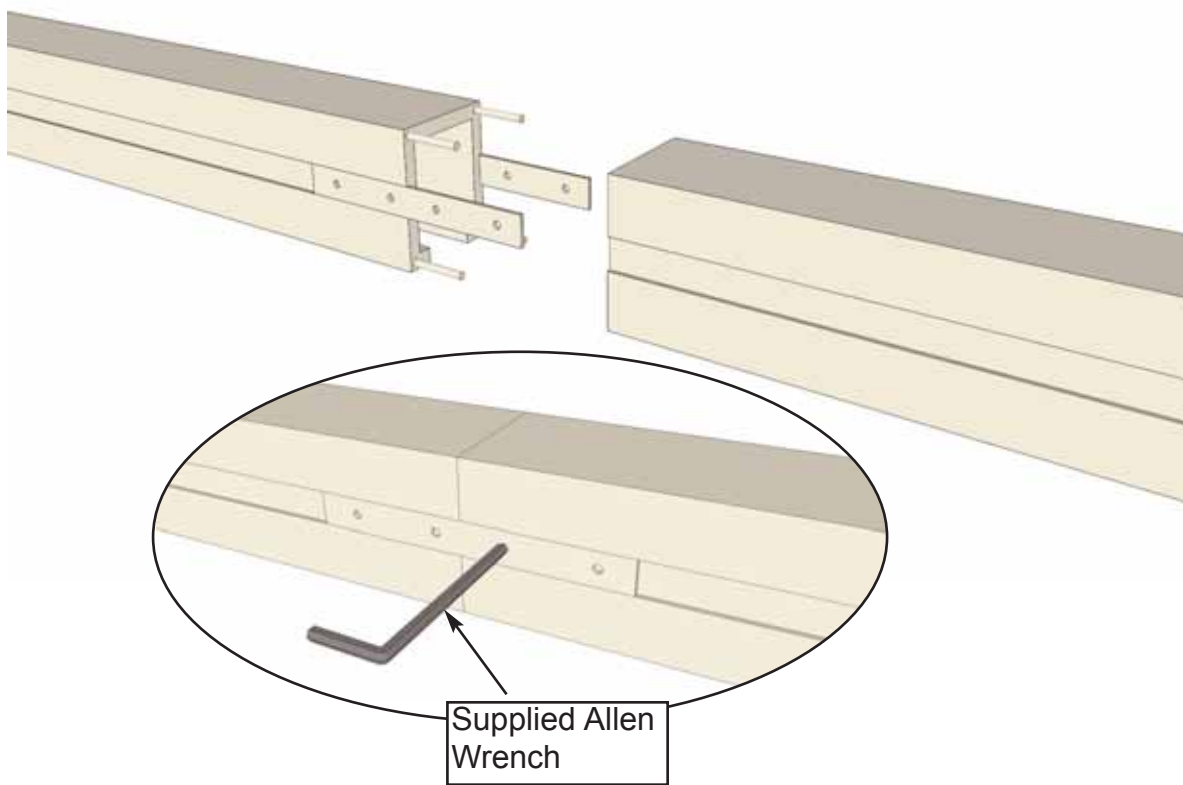

1. Locate **2 Piece Drive Beam Pieces (Parts A & B)**. Slide together and attach with supplied Set Screws using supplied Allen Wrench as shown above. Complete both faces of Beam.

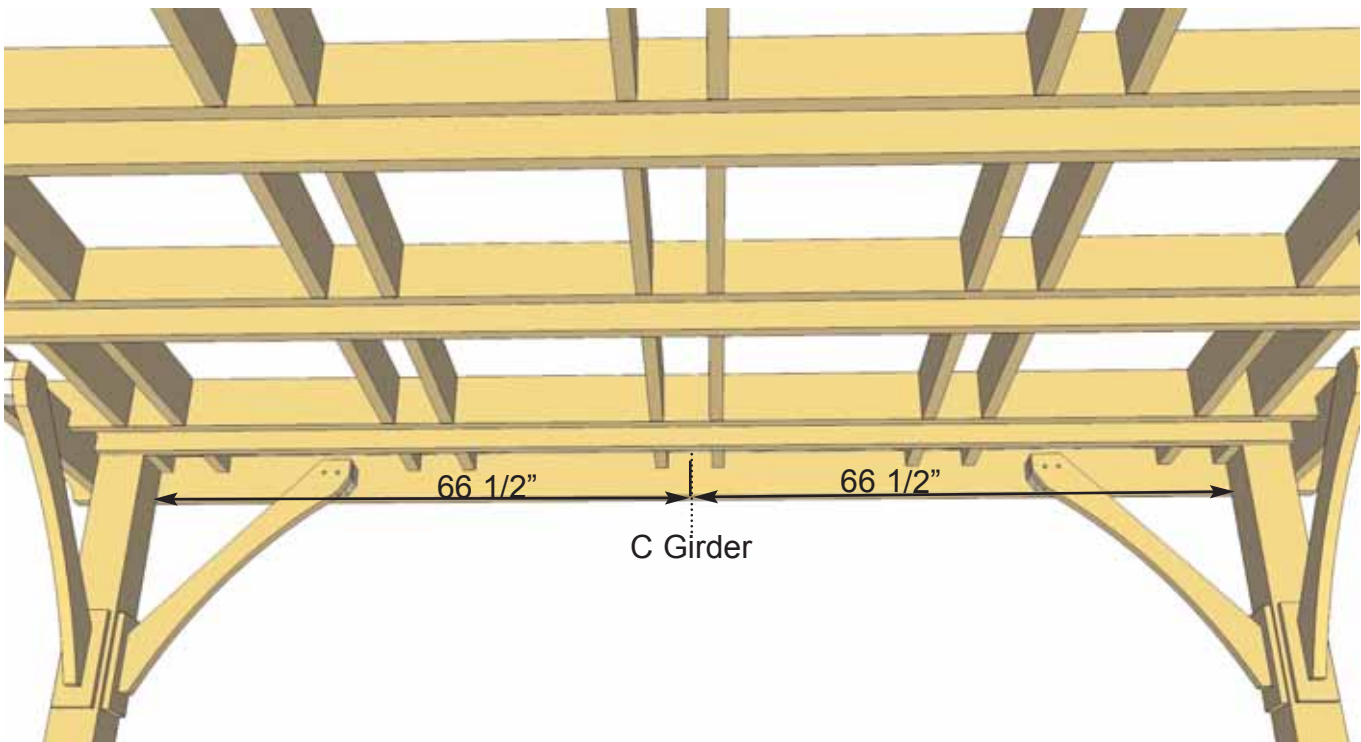

2. Find center point on C Girder between Posts (66 1/2") and mark.

3. With Step Ladders and another helper, lift up the Drive Beam and center on Girders. Be sure to decide first what end you want to designate as the stationary end of the Drive Beam. ie. The Canopy will always gather on this end and may block your view.

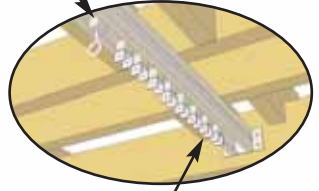

Decide what end you want the stationary part of the canopy to be on before securing.

4. Position Drive Beam so it is flush against bottom of joists (approximately 1" up from bottom of C Girders as illustrated to the right). Drive Beam should be evenly spaced between Pergola Posts (66 1/2"). Secure with 4 - 1 1/2" Pan Head Screws per end.

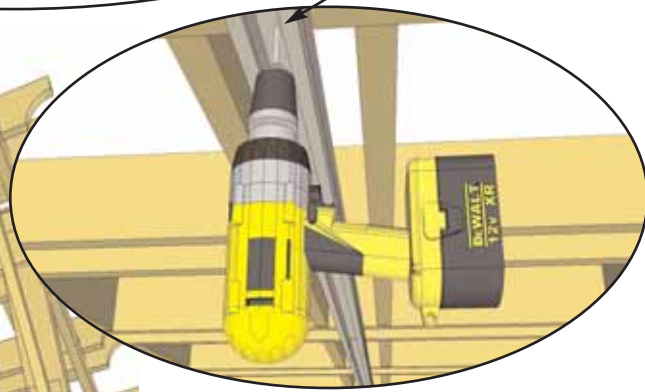
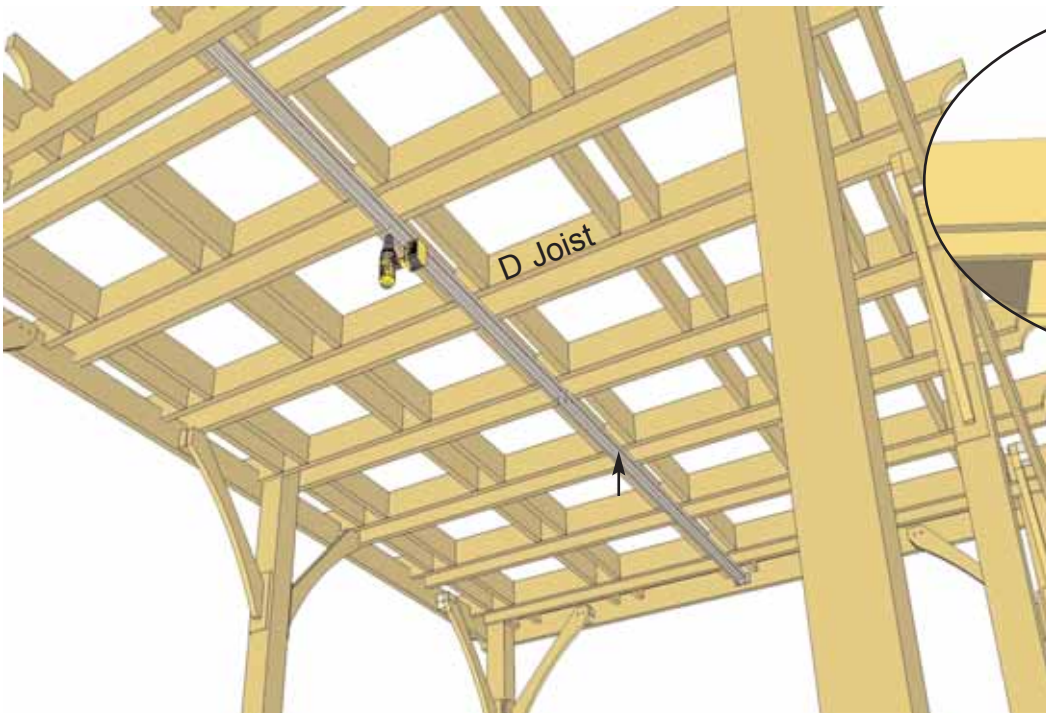
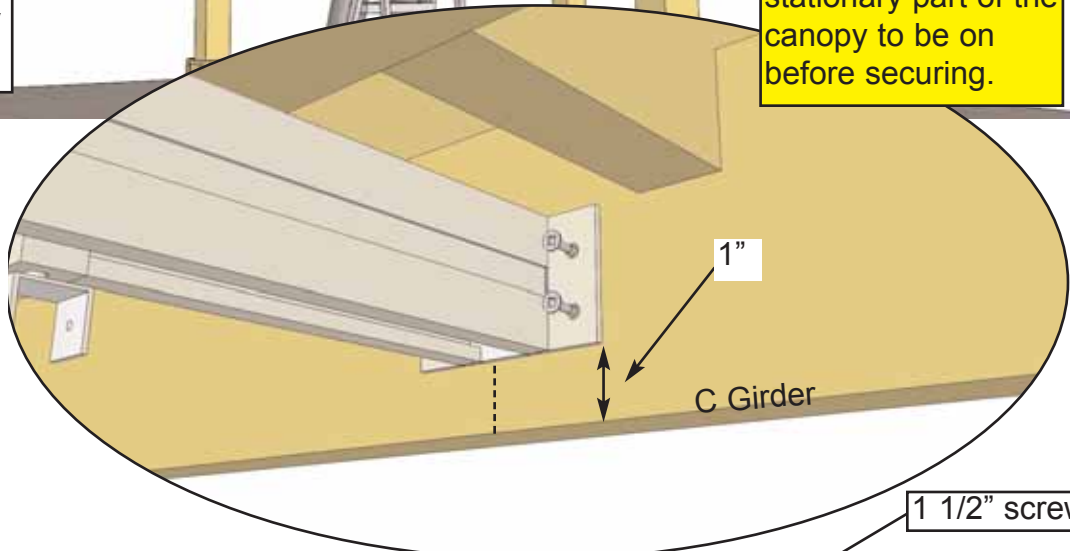

5. Secure Drive Beam to D Joist bottom with 2 - 1 1/2" Self Taping Screws as show above and to the left. When attaching, screw into center of D Joist. You may need a Bit Extension or have to drill a 1/16" pilot hole and finish with a screw driver.

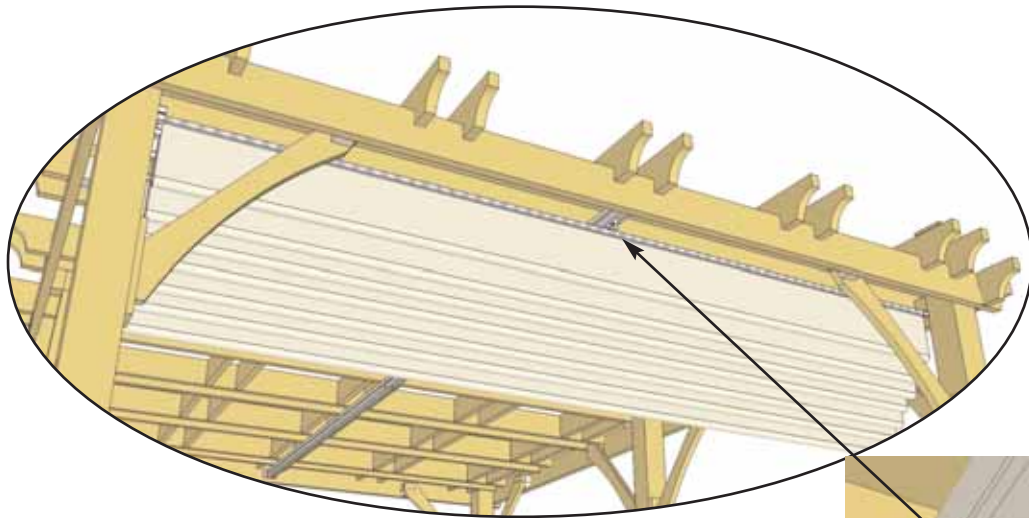

6. Have helper carefully lift up **Canopy Fabric with Aluminum Wings (Part C)** from the inside of the pergola. While standing on the outside on a ladder, line up 1st Wing hole with Drive Beam Rolling Bracket Holder hole.

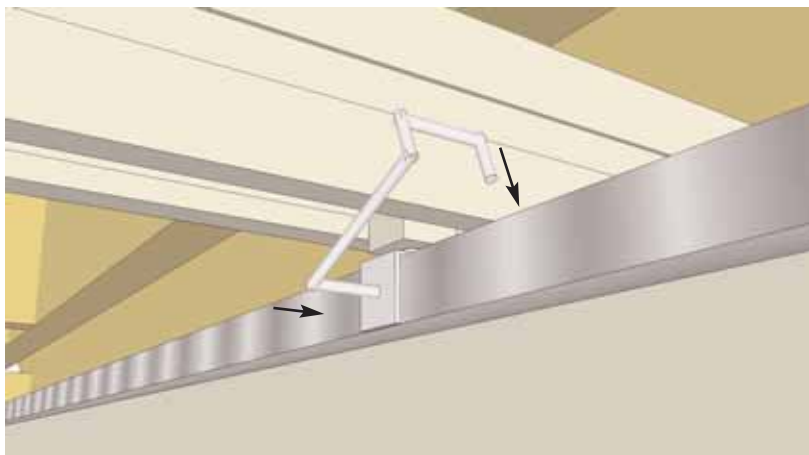
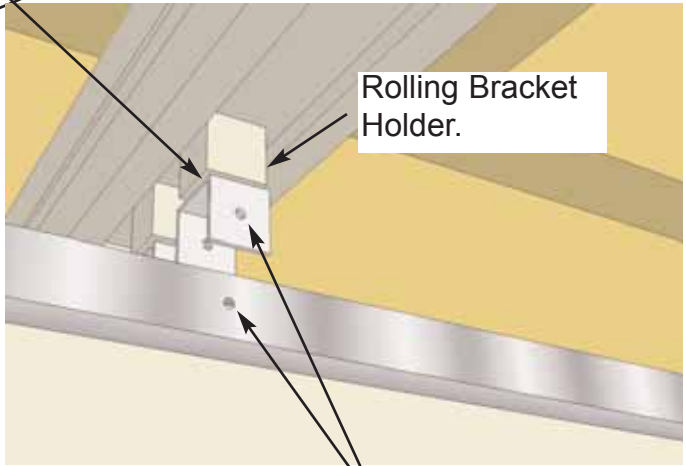

7. With holes lined up, slide **Canopy Locking Clip (Part D)** through holes and lock Wing to Bracket.

For the first Clip, you will need to start from the outside of the Pergola and then move to the inside of the Pergola for subsequent Clip attachments.

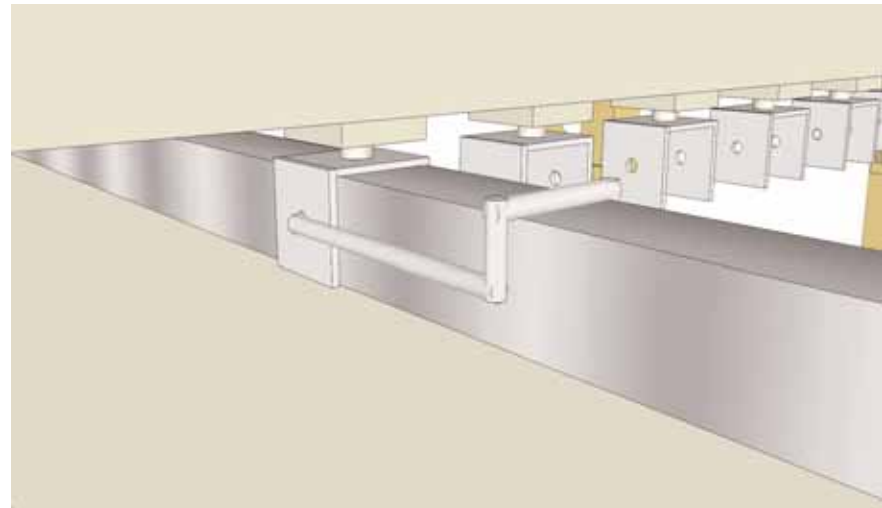

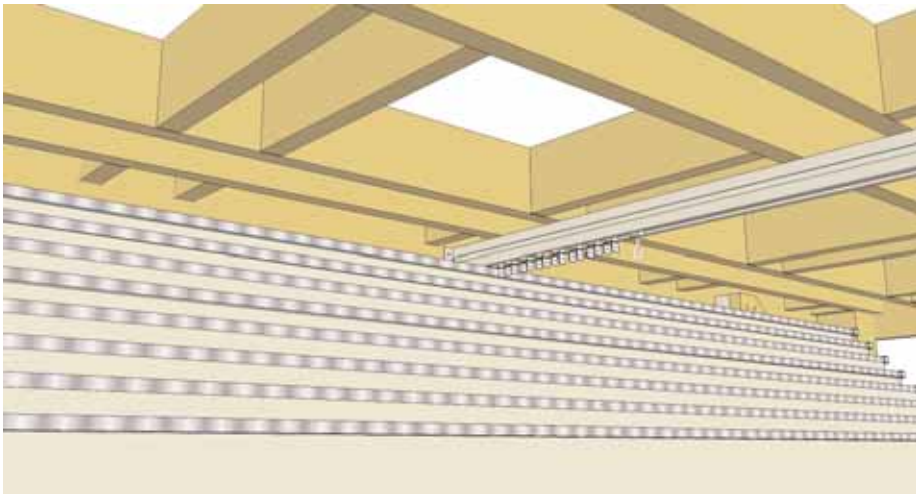

8. With helper still supporting the Canopy Fabric with Aluminum Wings, move to the inside and line up 2nd Wing hole with 2nd Drive Beam Rolling Bracket Holder hole.

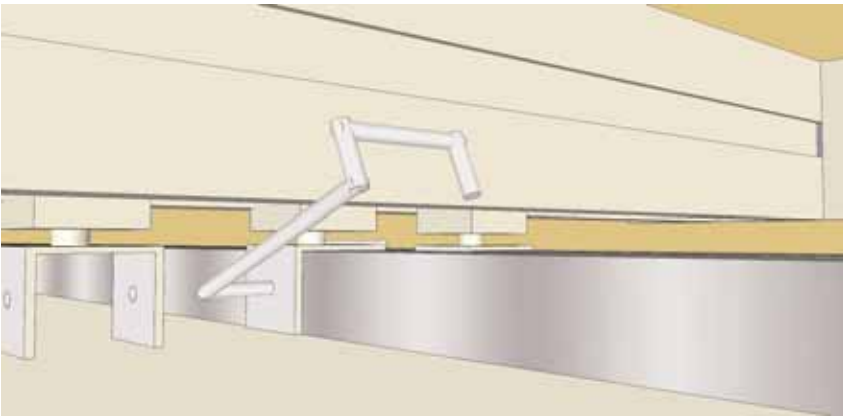
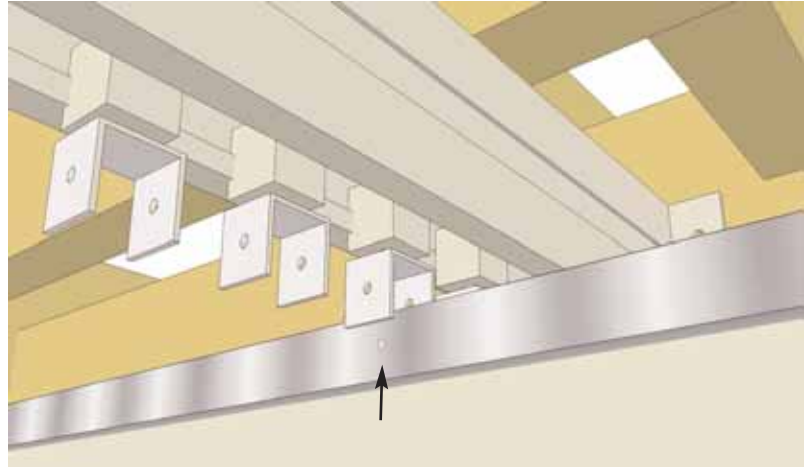

9. With holes lined up, slide Canopy Locking Clip through holes and lock Wing to Bracket as per **Step 7**.

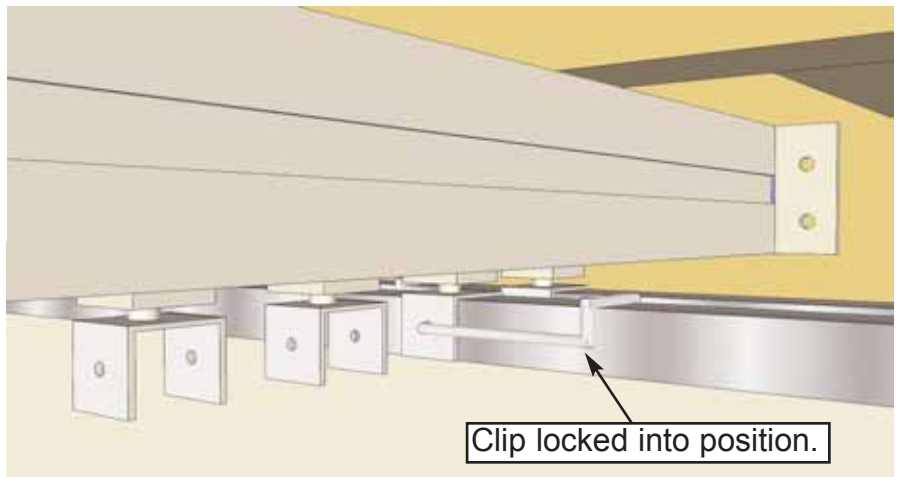

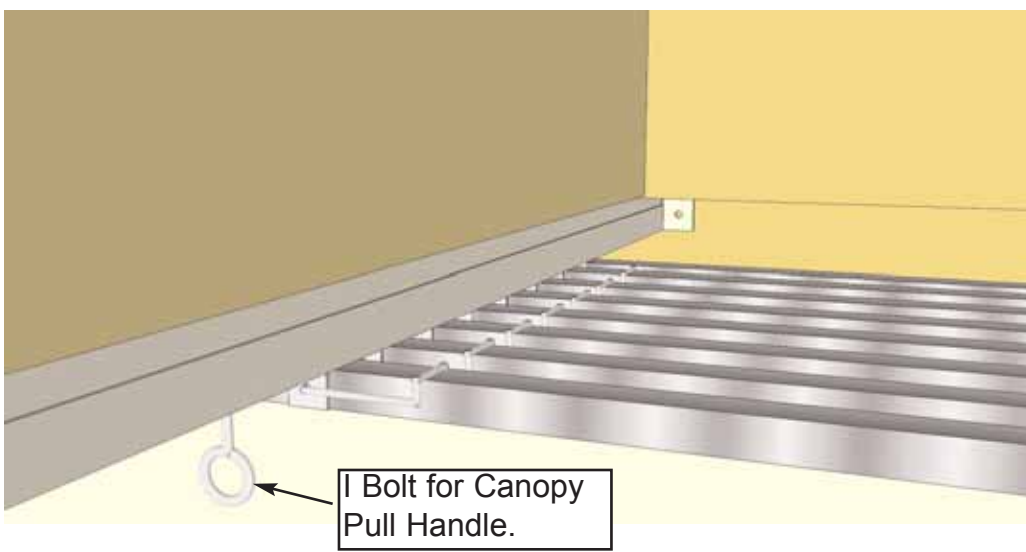

I Bolt for Canopy Pull Handle.

10. Complete remaining Canopy Locking Clip / Wing attachments as per **Steps 8 & 9.**

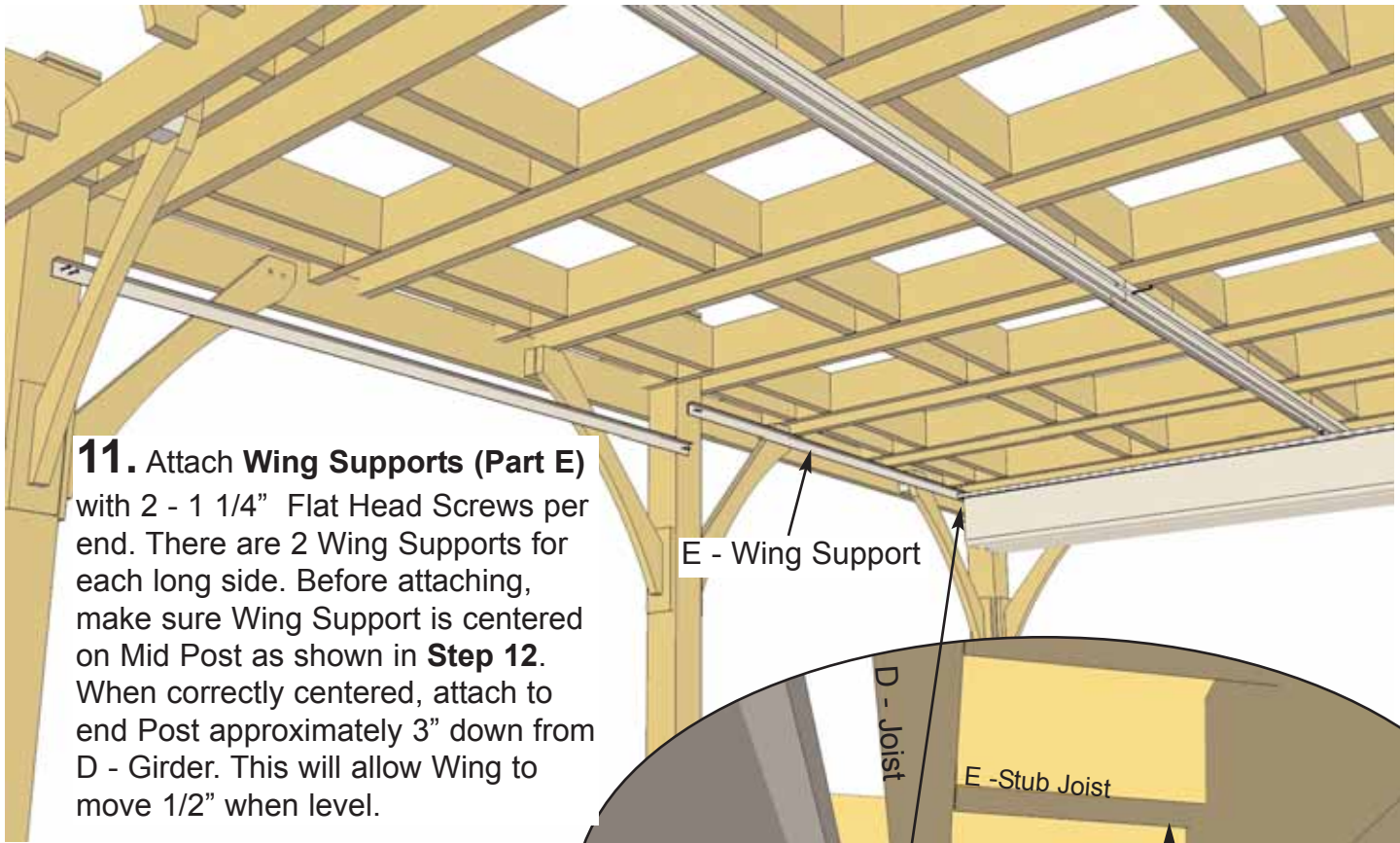

11. Attach **Wing Supports (Part E)** with 2 - 1 1/4" Flat Head Screws per end. There are 2 Wing Supports for each long side. Before attaching, make sure Wing Support is centered on Mid Post as shown in **Step 12.** When correctly centered, attach to end Post approximately 3" down from D - Girder. This will allow Wing to move 1/2" when level.

E - Wing Support

D - Joist

E - Stub Joist

3"

Wing Support

A - End Post

Approximately 1/2" of play is needed between the Wing and the Support to minimize tipping and telting in the wind.

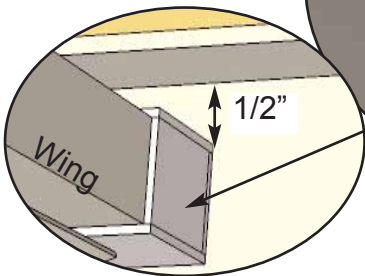

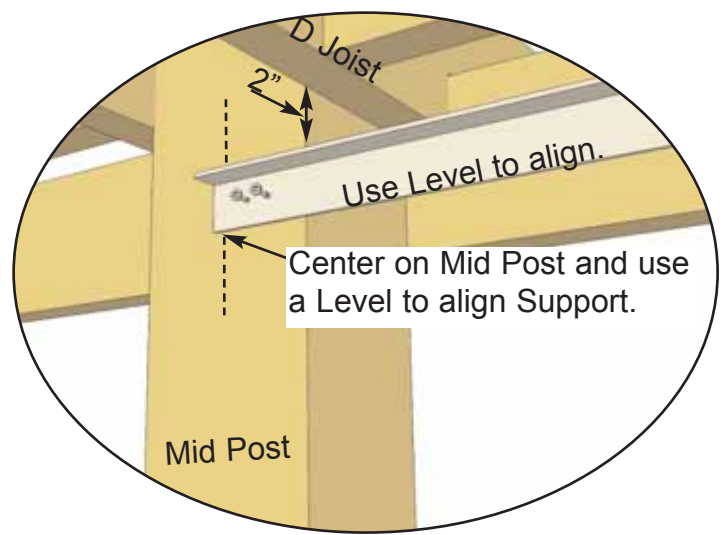
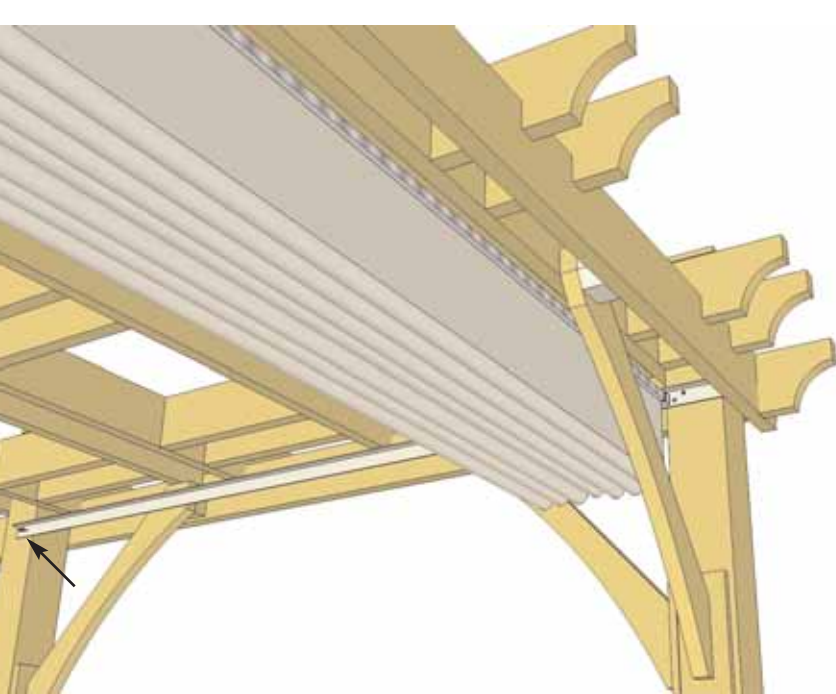

12. Attach Wing Support (Part E)

to Mid Post with 2 - 1 1/4" Flat Head Screws. Make sure Wing Support is centered on Post. Measure 2" down from the D-Joist as shown above. Level Support Wing before attaching.

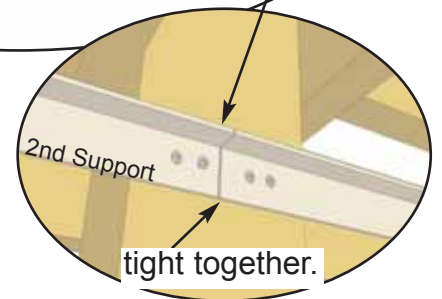
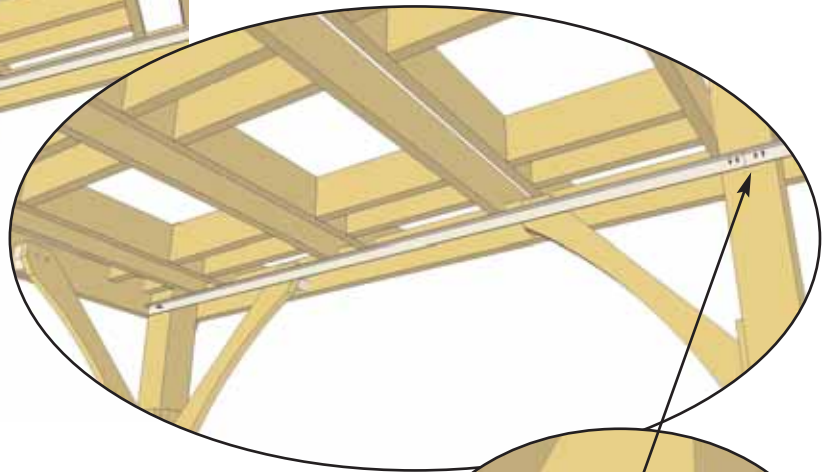
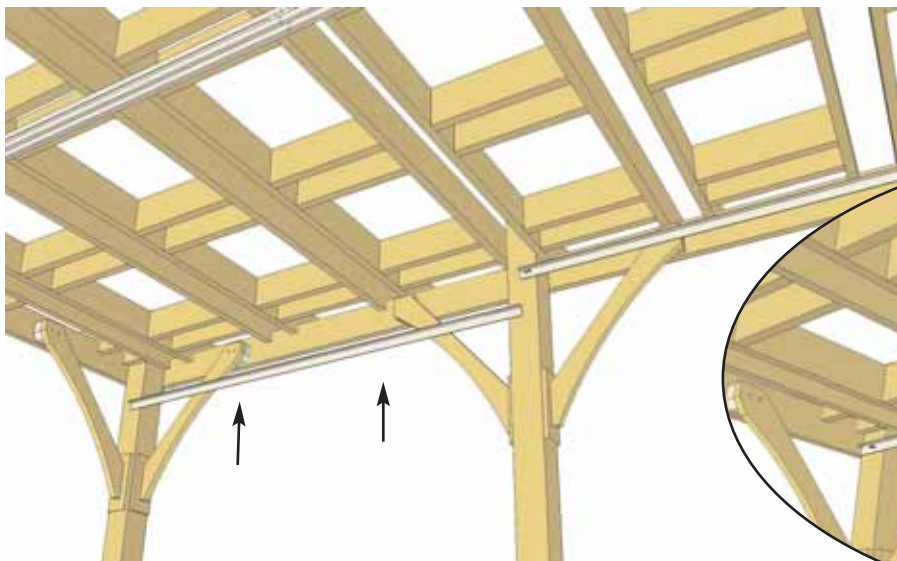

13. Attach 2nd Wing Support making sure to butt tight against end of attached Wing Support as shown above. Align at same vertical height and attach with 2 - 1 1/4" Flat Head Screws in each end. Complete Wing Support attachments on opposite side as Per **Steps 11-13.**

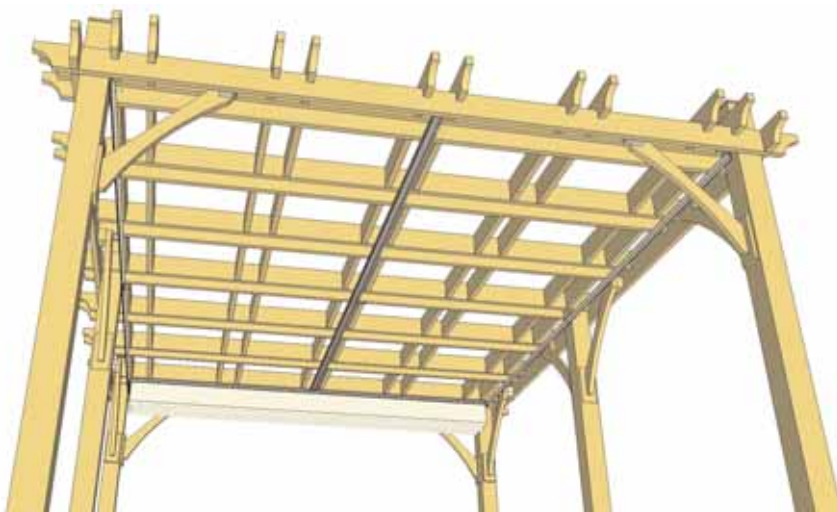

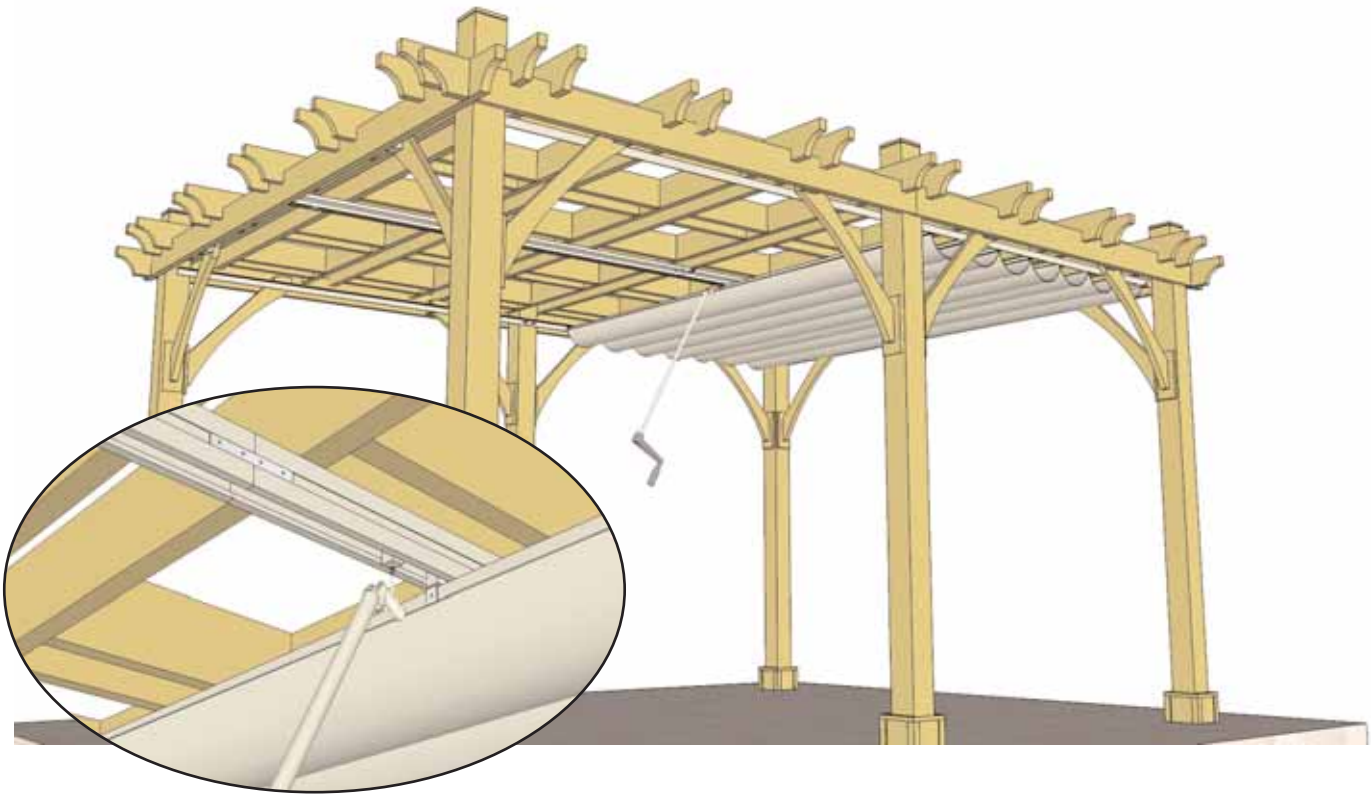

14. To retract the Canopy, unscrew locking I-Bolt with **Canopy Pull Handle (Part F)** and pull the Canopy to desired length and lock. To close, follow same procedure. Be sure to place Canopy Pull Handle in safe and secure location for future use.

Note; Wing Supports may need adjustment to allow for smooth pull of Canopy.

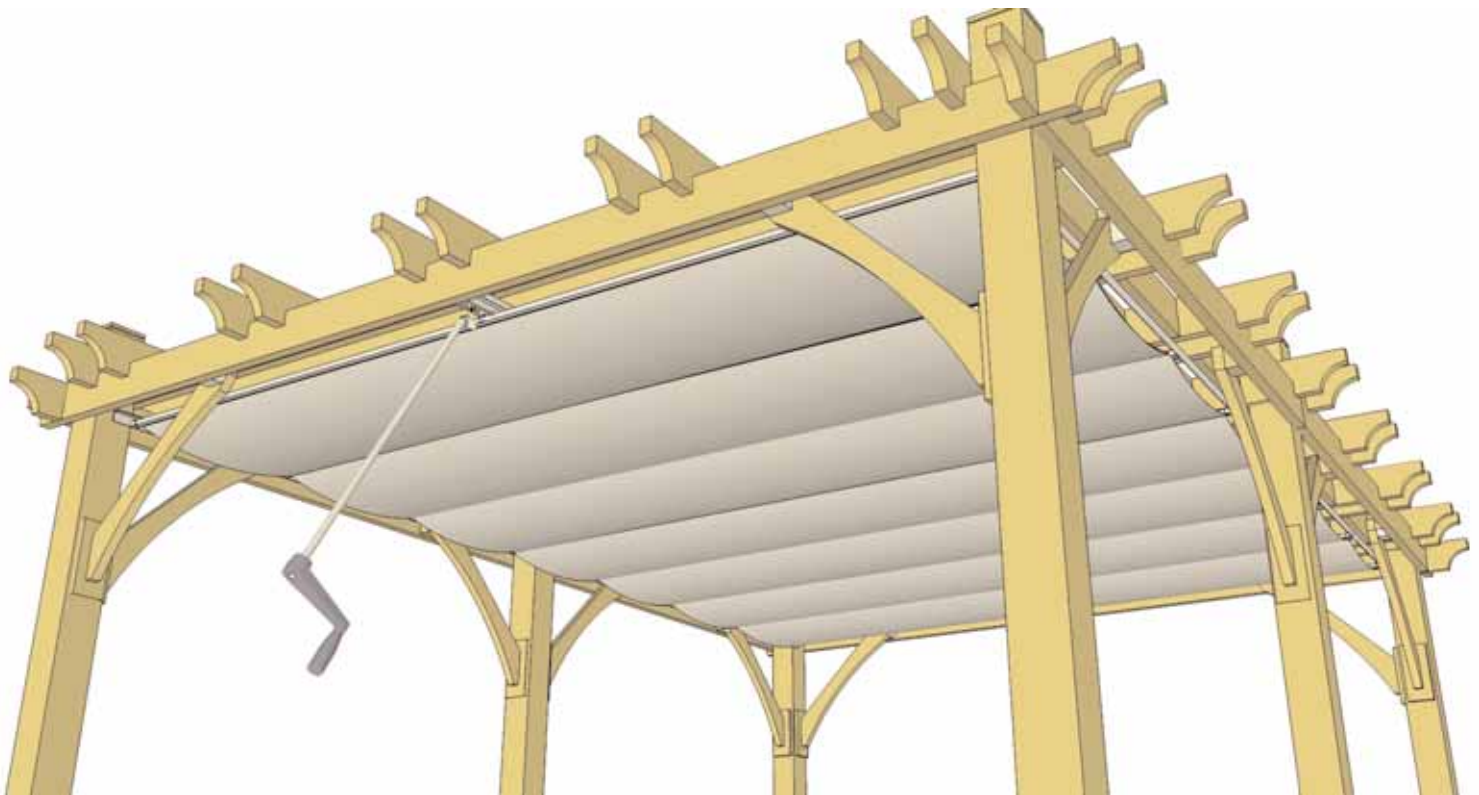

15. To retract the Canopy, locate the Canopy Pull Handle and place end into Locking I-Bolt. The Canopy can be locked and unlocked by turning the I-Bolt with the Pull Handle.

Congratulations on installing your Retractable Canopy for the 12x20 Shade Voila Pergola



Care and Maintenance -

U`!Áœ [] ã•Áœ^Á•ã }^áÁ Á^Á œ } œ &^Á^ÁË^Áœ [} œ^ÁÁœ^Á Á^Á [ç^Á
œ& { ~ |œ^ÁÁœ^Á áÁ^áiã ÁÁœ^Á^~ á^áÁ Á^Áœ^ÁÁ Á^Á [Á^Áœ^Á Á^Á } { }^Á^Á
^ [Á^Áœ^ÁÁ [áÁ^Á^* [áÁœ^Á] ^È

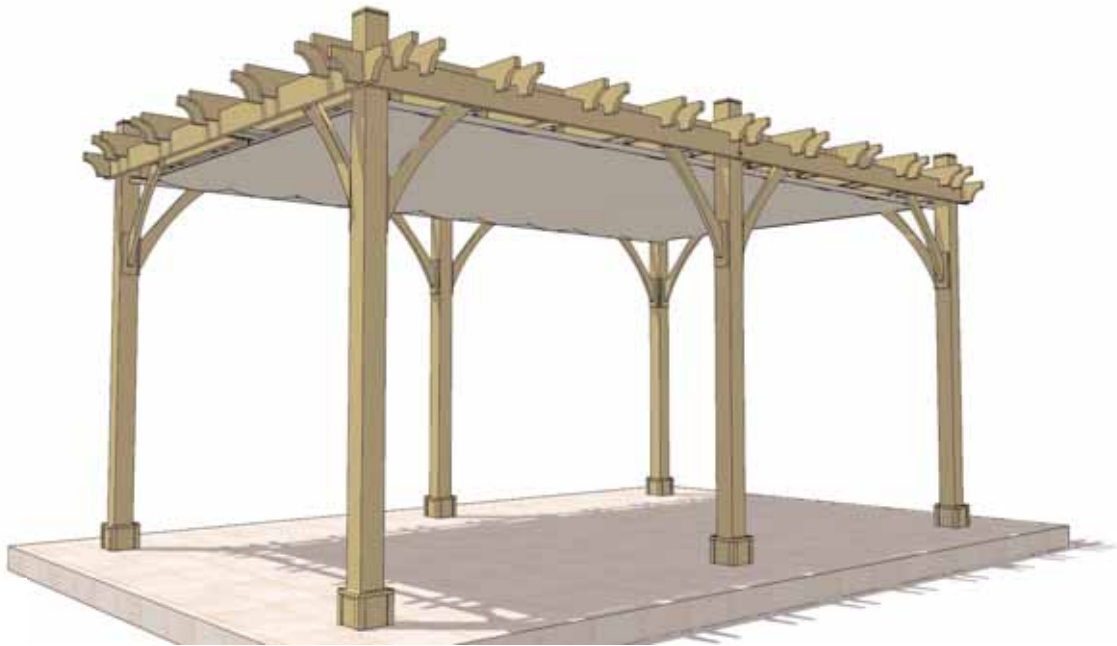

Y ^Áœ] ^Á [~!Áœ] ^Á } &^Á
œ•^ { àá * Á [~!Á^* [|áœ
à^^ } Á [œ] [•áá^Áœ áÁ
!^, œáá * È

Y ^Áœ] ^Á [~!Á^^ááœ Áœ á
[~!áÁ^Á Áœ^ÁÁÁ [{ Á [~
[] Áœ, Á^||Á^Áœ^Á [á * ÁÁœ
{ ||, á * Áœ^Áœ K

- 1. Customer Service
- 2. On Time Shipping
- 3. Motor Freight Delivery
- 4. Quality of Materials
- 5. Assembly Manual
- 6. Overall Satisfaction.



The materials contained in this Assembly Manual may be downloaded or copied provided that ALL copies retain the copyright and any other proprietary notices contained on the materials. No material may be modified, edited or taken out of context such that its use creates a false or misleading statement or impression as to the positions, statements or actions.

Ú|^œ^Áœ^ÁÁ íã^ÁÁ { œ^Á•ÁœK
Shade Voila
8695 Escarpment Way, Unit 9
Milton, Ontario.L9T 0J5
1-866-519-6150
support@shadevoila.com